

ELEMENT





EL CONCEPTO ELEMENT

ELEMENT es la respuesta de Normagrup al desafío medioambiental del siglo XXI gracias a un concepto innovador que sitúa la economía circular en el centro de un sistema de iluminación integral donde la luz recupera su protagonismo en el espacio. Un modelo que supera la fórmula tradicional basada en la obsolescencia de los equipos presentando un sistema donde los todos los componentes son reemplazables y reciclables.

UNA TECNOLOGÍA INNOVADORA

La tecnología de ELEMENT se basa en el dominio de la fuente de luz LED a través del Core, el núcleo común e intercambiable del sistema. Disponible en tres tamaños y con múltiples configuraciones lumínicas, el corazón de ELEMENT permite un control total de la luz en cualquier instalación, ofreciendo múltiples configuraciones y aportando el valor añadido del reemplazo de los equipos.

EL FUTURO ES CIRCULAR

En línea con la filosofía de las 4 R's, ELEMENT está orientado a alargar la vida de los productos, reduciendo la huella ecológica y la generación de residuos. Su diseño permite un sencillo reemplazo de las fuentes de luz. Las fuentes de luz pueden ser reparadas y reacondicionadas, dotándolas de una segunda vida. De este modo se alarga el ciclo operativo de las luminarias.

UN SISTEMA ESCALABLE

ELEMENT fusiona tecnología y estética para presentar un lenguaje visual contemporáneo que permite un desarrollo arquitectónico sin límites en el espacio, conectando los espacios exteriores e interiores a través de la luz. Un sistema escalable con múltiples familias de luminarias basadas en distintas líneas de diseño, funciones y tipos de instalación para combinar elementos y desarrollar una instalación de forma personalizada.

PLUG & LIGHT

ELEMENT destaca por la sencillez de configuración, diseño y composición de instalaciones a todas las escalas gracias al sistema de conexión rápida Plug & Light desarrollado por Normagrup. Una fórmula que permite intercambiar fuentes de luz Core LED de manera rápida y sencilla, en combinación con una amplia gama de luminarias adaptable a todo tipo de escenas y características arquitectónicas.

UNA LUZ DE CALIDAD

La tecnología Core permite combinar múltiples características lumínicas bajo una misma estética, variando fácilmente parámetros como la temperatura de color, la fidelidad del color, la óptica o los ángulos de visión. Además, ELEMENT incluye una versión con un índice CRI 98 y reducción de luz azul-violeta, asociada al cansancio y al estrés visual, garantizando una calidad de la luz excelente.

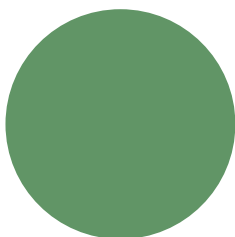

DRIVER

CUERPO

ANTIDESLUMBRANTE



El sistema ELEMENT ofrece una gran flexibilidad a la hora de elegir la iluminación que mejor se adapte a cualquier entorno gracias a su sistema de conexión. Combinando diferentes módulos, podemos crear más de 10.000 combinaciones únicas que se ajustan a las necesidades específicas de cada espacio. Para facilitar aún más la personalización y selección de opciones, el sistema dispone de un configurador on line en nuestra página web.

PORTALÁMPARAS

Disponibles en tres tamaños (HN35, HN50 y HN110), estos portalámparas proporcionan la estructura básica para la conexión de los módulos.

FUENTES DE LUZ

Ofrecen una amplia gama de opciones de iluminación, incluyendo diferentes ángulos de apertura, temperaturas de color y CRI (índice de reproducción de color).

ELEMENT no solo brinda versatilidad, sino que también se convierte en la base fundamental del concepto de sostenibilidad y circularidad. Su diseño modular permite un fácil montaje, desmontaje y reconfiguración, optimizando el uso de los recursos y minimizando el impacto ambiental.



EL SISTEMA ELEMENT

Disfruta de una composición personalizada del espacio con múltiples configuraciones lumínicas, diseños y modos de instalación.

FUENTES DE LUZ

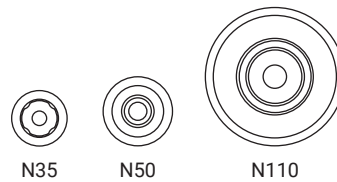

INSTALACIÓN

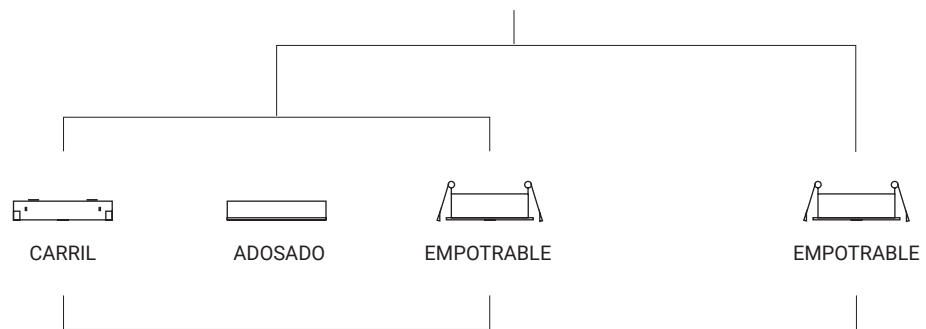

LUMINARIAS

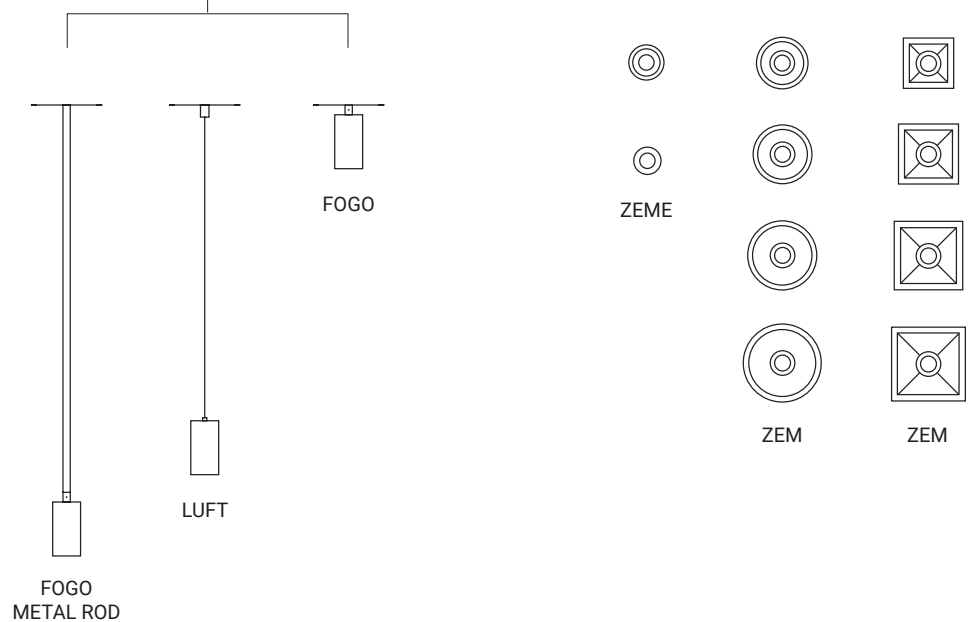

FUENTES DE LUZ

CORE



CORE N35
11



CORE N50
12

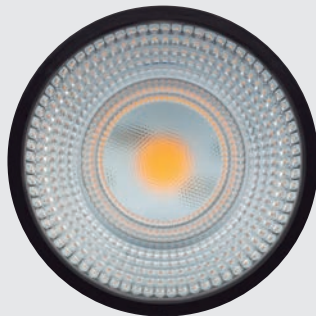

CORE N110
13



LUMINARIAS



FOGO
20



ZEME
38



FOGO METAL ROD
26



ZEM
40



LUFT
32

ACCESORIOS

RAIL
48

RAIL MICRO
52

**FUENTES
DE ALIMENTACIÓN**
56

FUENTES DE LUZ

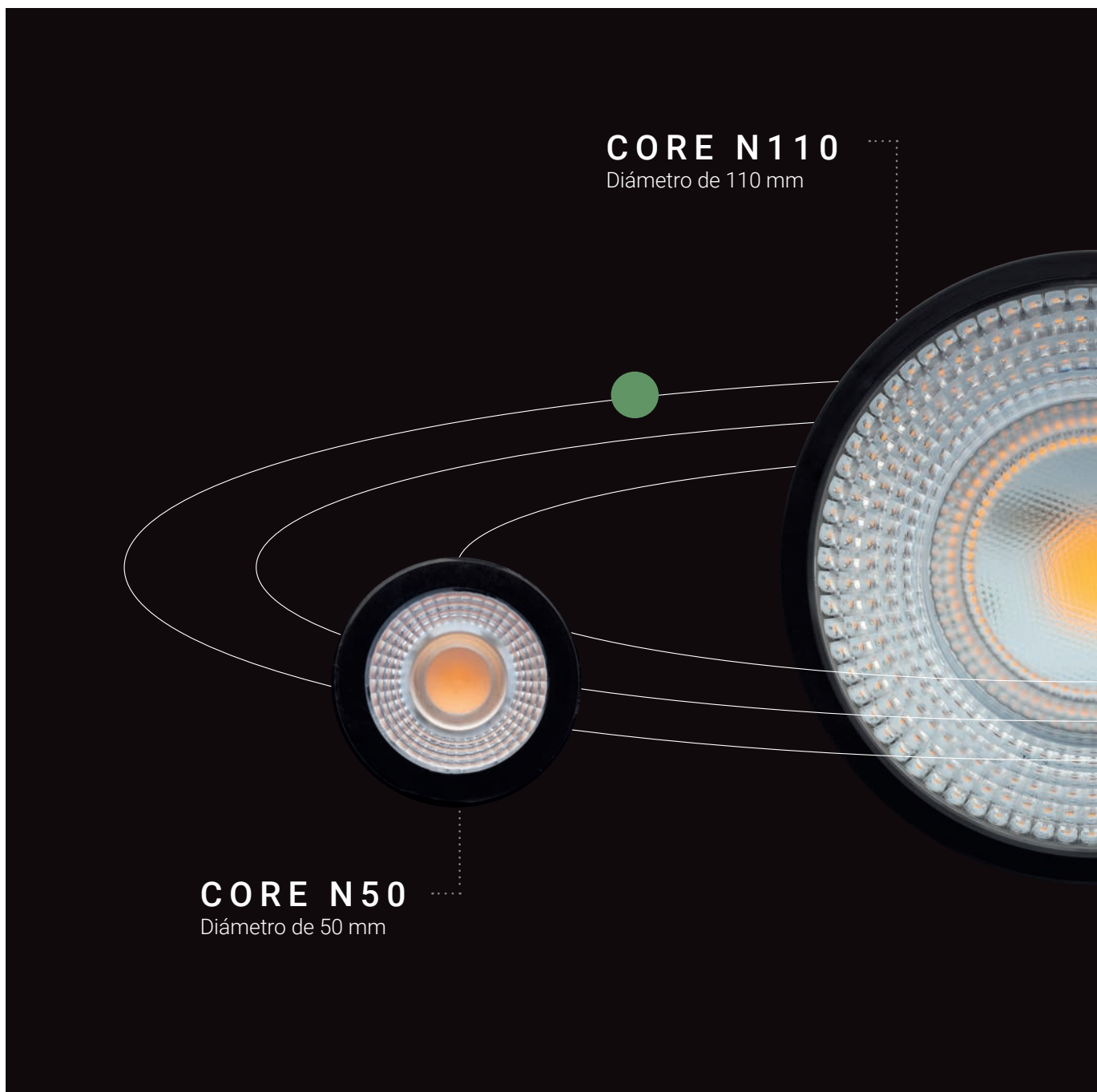

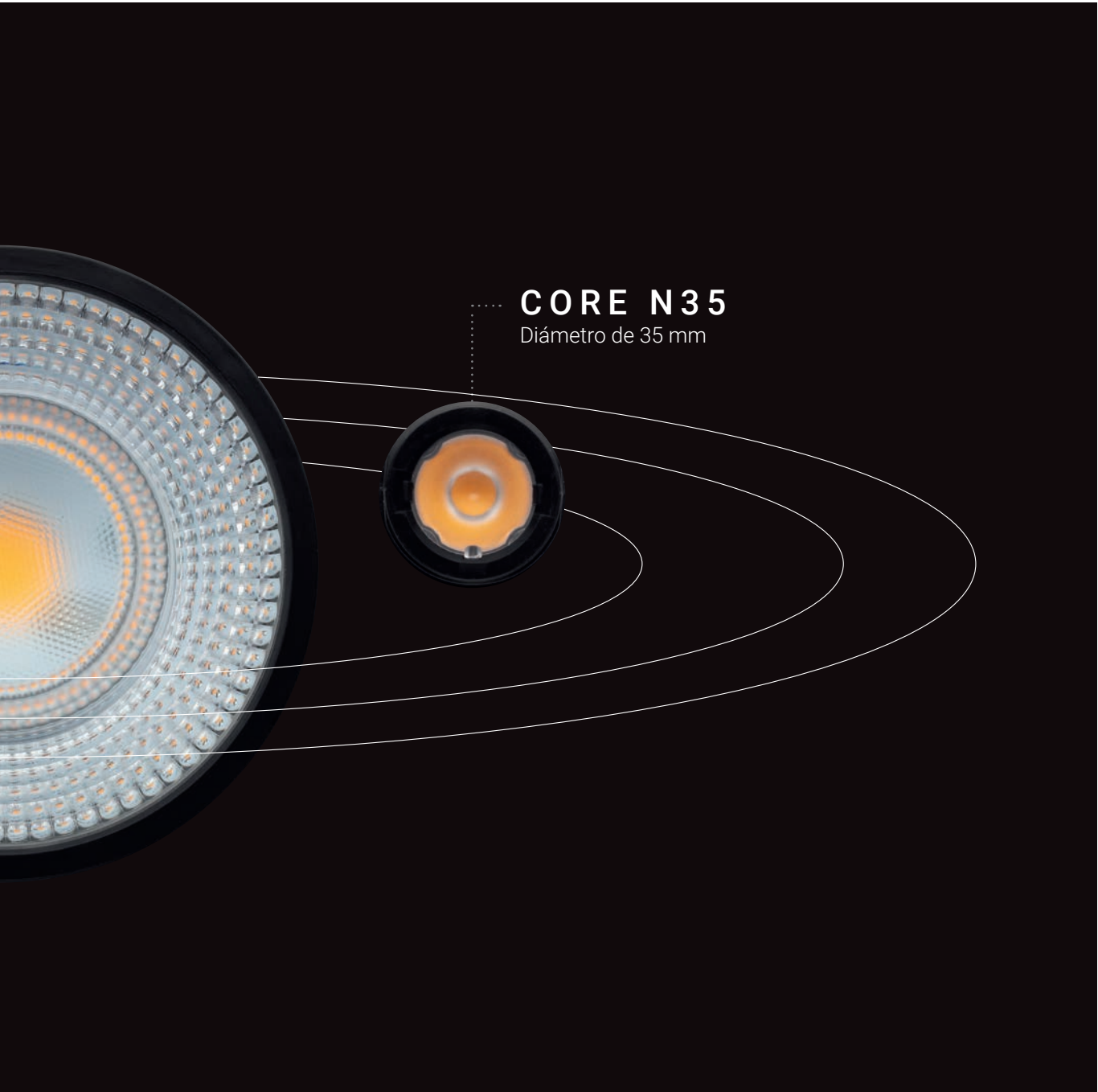

CORE N35
Diámetro de 35 mm

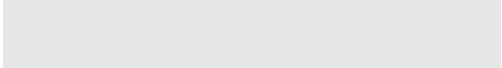

CORE



	CORE N35	CORE N50	CORE N110
Difusor	Lente PMMA	Lente PMMA	Lente PMMA
Fuente de luz	LED	LED	LED
Seguridad fotobiológica	1	1	1
CRI	80-95	80-98	80-98
Elipses de Macadam	3	3	3
Rango ángulos de apertura	20 35	20 35 60	20 35 60
Potencia máx. (W)	2,3	6,9	20,4
Temperatura de color (°K)	2700 3000 4000	2700 3000 4000	2700 3000 4000
Rango lumínico	275-325	645-865	1910-3420
Factor de potencia	0,5	0,93	0,95 0,97
Rendimiento (%)	88	83,5	86
Expectativa	108000h L80B10	66000h L80B10	66000h L80B10
Opción DALI	✓	✓	✓
Funcionamiento continuado 24h	✓	✓	✓
IP	20	20	20
Clase	III	II	II



CORE N35

		K	REF.		LUMEN	W (máx.)		PVP (€)
CORE N35	CRI 80	2700	N35-82S	20°	325 lm	2,3 W	0,03	20,25 €
			N35-82M	35°	325 lm	2,3 W	0,03	20,25 €
		3000	N35-83S	20°	340 lm	2,3 W	0,03	20,25 €
			N35-83M	35°	340 lm	2,3 W	0,03	20,25 €
		4000	N35-84S	20°	355 lm	2,3 W	0,03	20,25 €
			N35-84M	35°	355 lm	2,3 W	0,03	20,25 €
	CRI 95	2700	N35-92S	20°	275 lm	2,3 W	0,03	23,25 €
			N35-92M	35°	275 lm	2,3 W	0,03	23,25 €
		3000	N35-93S	20°	290 lm	2,3 W	0,03	23,25 €
			N35-93M	35°	290 lm	2,3 W	0,03	23,25 €
		4000	N35-94S	20°	300 lm	2,3 W	0,03	23,25 €
			N35-94M	35°	300 lm	2,3 W	0,03	23,25 €

Seguridad fotobiológica

RG1+ **1** Bajo riesgo

* Tiempo inferior a 3 h. mirando fijamente a la fuente de luz

	REF.		PVP (€)
ANTIDESLUMBRANTE	N35-ADB		1,95 €
	N35-ADN		1,95 €
	N35-ADC		4,75 €
	N35-ADL		4,75 €
	N35-ADO		4,75 €
	N35-ADR		4,75 €

	REF.	PVP (€)
EXTRACTOR	N35-EX	2,25 €

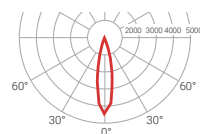
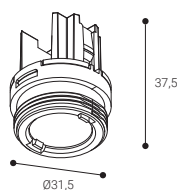
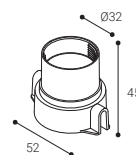

— C0-C180 $\eta=88\%$
— C90-C270



20°

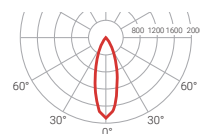

— C0-C180 $\eta=81\%$
— C90-C270



35°



CORE N50

		K	REF.	Beam	LUMEN	W (máx.)	TH	PVP (€)
CORE N50	CRI 80	2700	N50-82S	20°	810 lm	6,9 W	0,09	21,00 €
			N50-82M	35°	810 lm	6,9 W	0,09	21,00 €
			N50-82F	60°	810 lm	6,9 W	0,09	21,00 €
		3000	N50-83S	20°	845 lm	6,9 W	0,09	21,00 €
			N50-83M	35°	845 lm	6,9 W	0,09	21,00 €
			N50-83F	60°	845 lm	6,9 W	0,09	21,00 €
	4000	N50-84S	20°	865 lm	6,9 W	0,09	21,00 €	
			35°	865 lm	6,9 W	0,09	21,00 €	
			60°	865 lm	6,9 W	0,09	21,00 €	
		N50-92S	20°	645 lm	6,9 W	0,09	25,50 €	
			35°	645 lm	6,9 W	0,09	25,50 €	
			60°	645 lm	6,9 W	0,09	25,50 €	
3000	N50-93S	20°	680 lm	6,9 W	0,09	25,50 €		
		35°	680 lm	6,9 W	0,09	25,50 €		
		60°	680 lm	6,9 W	0,09	25,50 €		
4000	N50-94S	20°	745 lm	6,9 W	0,09	25,50 €		
		35°	745 lm	6,9 W	0,09	25,50 €		
		60°	745 lm	6,9 W	0,09	25,50 €		

	REF.	Beam	PVP (€)
ANTIDESLUMBRANTE	N50-ADB	○	2,50 €
	N50-ADN	●	2,50 €
	N50-ADC	●	6,50 €
	N50-ADL	●	6,50 €
	N50-ADO	●	6,50 €
	N50-ADR	●	6,50 €

	REF.	PVP (€)
EXTRACTOR	N50-EX	2,95 €

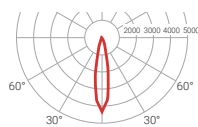
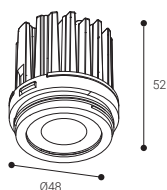
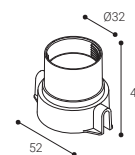

CO-C180 C90-C270 $\eta=79\%$

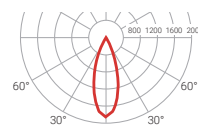

CO-C180 C90-C270 $\eta=77\%$

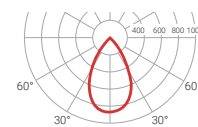

CO-C180 C90-C270 $\eta=84\%$



20°



35°



60°



CORE N110

		K	REF.	Beam	LUMEN	W (máx.)	THD	PVP (€)
CORE N110	CRI 80	2700	N110-82S	20°	3045 lm	20,4 W	0,53	66,15 €
			N110-82M	35°	3045 lm	20,4 W	0,53	66,15 €
			N110-82F	60°	3045 lm	20,4 W	0,53	66,15 €
		3000	N110-83S	20°	3180 lm	20,4 W	0,53	66,15 €
			N110-83M	35°	3180 lm	20,4 W	0,53	66,15 €
			N110-83F	60°	3180 lm	20,4 W	0,53	66,15 €
	4000	N110-84S	20°	3420 lm	20,4 W	0,53	66,15 €	
		N110-84M	35°	3420 lm	20,4 W	0,53	66,15 €	
		N110-84F	60°	3420 lm	20,4 W	0,53	66,15 €	
	CRI 98	2700	N110-92S	20°	1910 lm	20,4 W	0,53	78,25 €
			N110-92M	35°	1910 lm	20,4 W	0,53	78,25 €
			N110-92F	60°	1910 lm	20,4 W	0,53	78,25 €
3000		N110-93S	20°	2020 lm	20,4 W	0,53	78,25 €	
		N110-93M	35°	2020 lm	20,4 W	0,53	78,25 €	
		N110-93F	60°	2020 lm	20,4 W	0,53	78,25 €	
4000	N110-94S	20°	2220 lm	20,4 W	0,53	78,25 €		
	N110-94M	35°	2220 lm	20,4 W	0,53	78,25 €		
	N110-94F	60°	2200 lm	20,4 W	0,53	78,25 €		

	REF.	Color	PVP (€)
ANTIDESLUMBRANTE	N110-ADB	White	3,75 €
	N110-ADN	Black	3,75 €
	N110-ADC	Brown	8,50 €
	N110-ADL	Grey	8,50 €
	N110-ADO	Olive	8,50 €
	N110-ADR	Dark Brown	8,50 €

	REF.	PVP (€)
EXTRACTOR	N110-EX	2,95 €

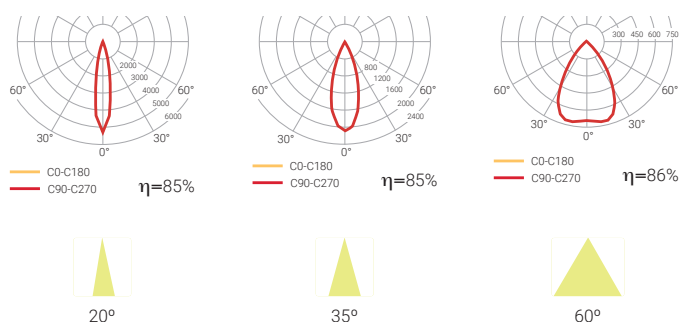
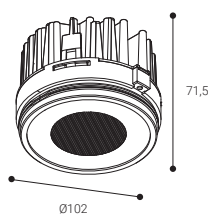

LUMINARIAS





COLORES

Element ofrece la posibilidad de elegir entre seis colores inspirados en la naturaleza para personalizar el espacio.

**Colores espaciales.
Gama de fríos**

- Blanco Astral
- Negro Galaxia
- Gris Lunar

**Colores naturales.
Gama de cálidos**

- Arce Rojo
- Álamo Dorado
- Roble Marrón

CONFIGURADOR DE COLORES

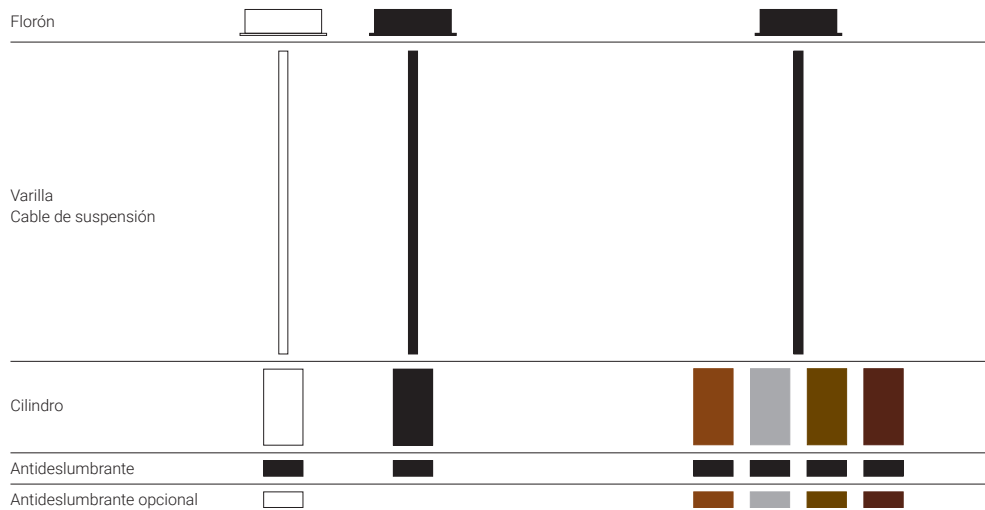

Normagrup
360 | Otros acabados
consultar









FOGO



FOCX-3

Colores estándar

Gama de colores disponibles



— Código color



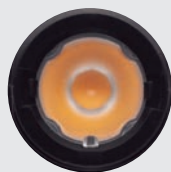

CORE N35



FOGO

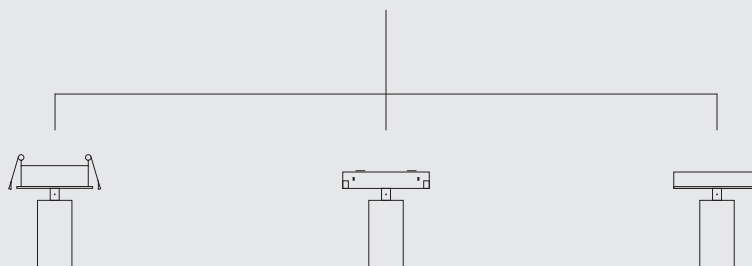

EMPOTRADO A TECHO

CARRIL ELECTRIFICADO
24 Vcc

ADOSADO A TECHO

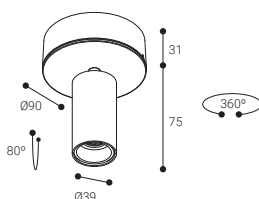
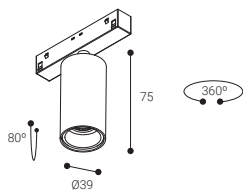
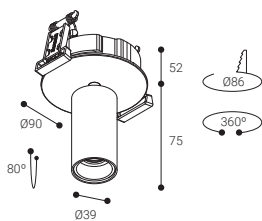

IP 20

	REF.	⚡	W	📐	🏠	PVP (€)
EMPOTRADO A TECHO	FORB-3DC*	24 Vcc	2,3 W	○	0,17	128,00 €
	FORB-3	230 Vca	2,3 W	○	0,21	152,45 €

* Fuente de alimentación 24Vcc no incluida

CARRIL ELECTRIFICADO	FOCB-3DC*	24 Vcc	2,3 W	○	0,01	162,50 €
----------------------	-----------	--------	-------	---	------	----------

* Fuente de alimentación 24Vcc no incluida

ADOSADO A TECHO	FOSB-3DC*	24 Vcc	2,3 W	○	0,18	128,00 €
	FOSB-3	230 Vca	2,3 W	○	0,23	186,95 €

* Fuente de alimentación 24Vcc no incluida

+ Añadir referencia CORE N35



CORE N50



FOGO

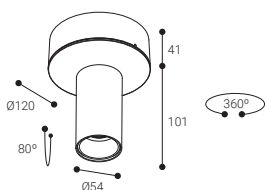
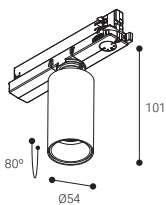
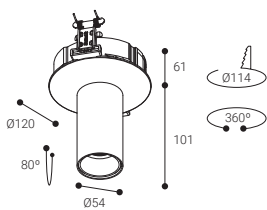
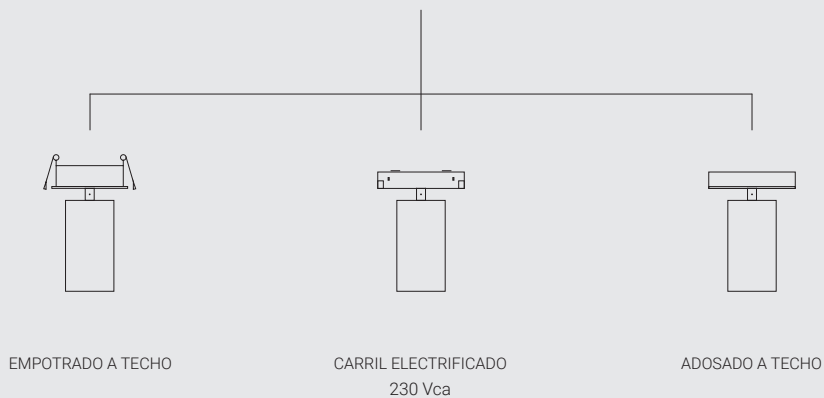

IP 20

	REF.	⚡	W	🌀	🏠	PVP (€)
EMPOTRADO A TECHO	FORB-52	230 Vca	6,9 W	○	0,24	163,75 €
	FORDB-52	230 Vca	6,9 W	○	0,24	193,75 €

CARRIL ELECTRIFICADO	FOCB-52	230 Vca	6,9 W	○	0,28	113,00 €
	FOCDB-52	230 Vca	6,9 W	○	0,28	174,50 €

ADOSADO A TECHO	FOSB-52	230 Vca	6,9 W	○	0,22	163,75 €
	FOSDB-52	230 Vca	6,9 W	○	0,22	193,75 €

+ Añadir referencia CORE N50

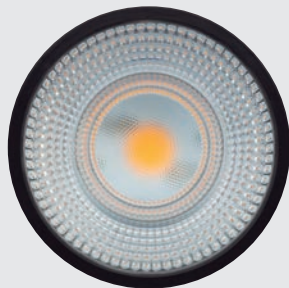

CORE N110



FOGO

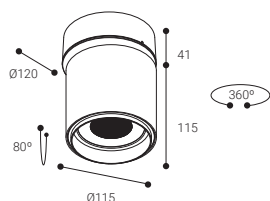
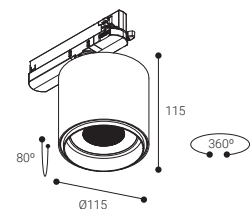
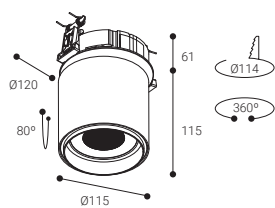
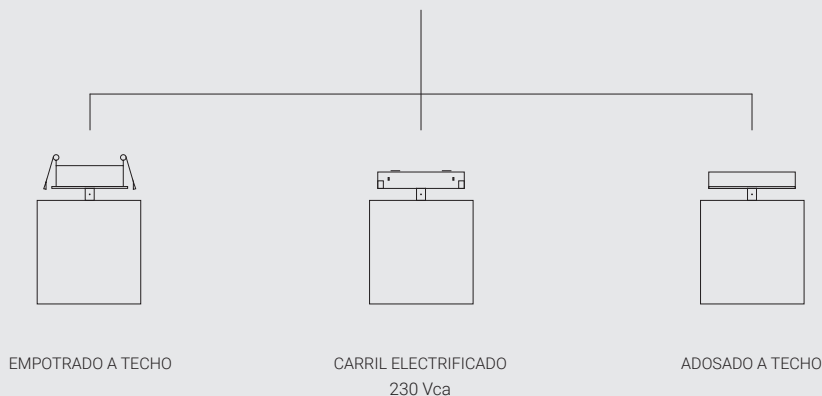

IP 20

	REF.	⚡	W	📐	🏠	PVP (€)
EMPOTRADO A TECHO	FORB-13	230 Vca	11,8 W	○	0,48	163,25 €
	FORB-16	230 Vca	20,4 W	○	0,48	163,25 €
	FORDB-13	230 Vca	11,8 W	○	0,48	193,25 €
	FORDB-16	230 Vca	20,4 W	○	0,48	193,25 €

CARRIL ELECTRIFICADO	FOCB-13	230 Vca	11,8 W	○	0,58	128,25 €
	FOCB-16	230 Vca	20,4 W	○	0,58	128,25 €
	FOCDB-13	230 Vca	11,8 W	○	0,58	189,75 €
	FOCDB-16	230 Vca	20,4 W	○	0,58	189,75 €

ADOSADO A TECHO	FOSB-13	230 Vca	11,8 W	○	0,50	163,25 €
	FOSB-16	230 Vca	20,4 W	○	0,50	163,25 €
	FOSDB-13	230 Vca	11,8 W	○	0,50	193,25 €
	FOSDB-16	230 Vca	20,4 W	○	0,50	193,25 €

+ Añadir referencia CORE N110





FOGO

METAL ROD



FOCX-3

Colores estándar

Gama de colores disponibles



— Código color



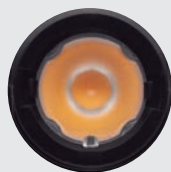

CORE N35



FOGO METAL ROD

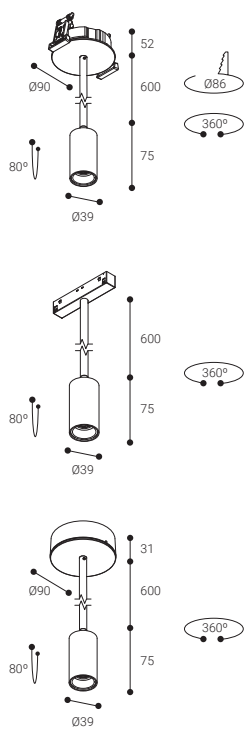
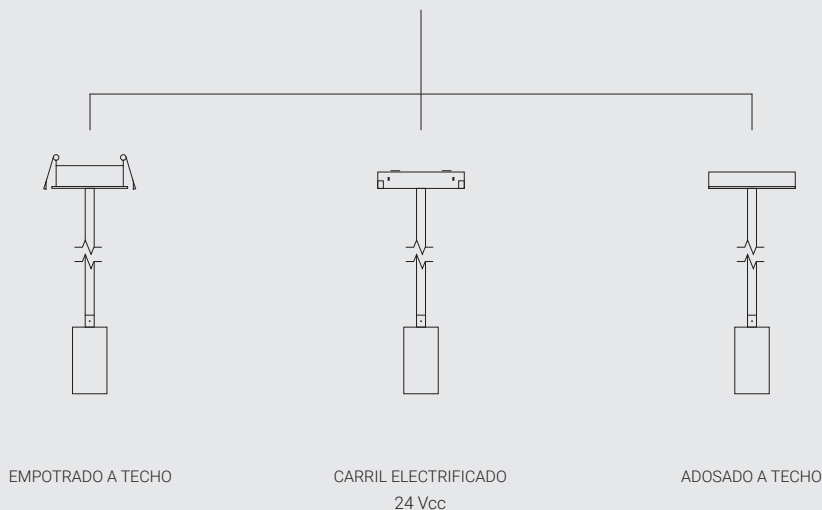

IP 20

	REF.	⚡	W	📐	🏠	PVP (€)
EMPOTRADO A TECHO	FMRB-3DC*	24 Vcc	2,3 W	○	0,36	142,25 €
	FMRB-3	230 Vca	2,3 W	○	0,40	166,70 €

* Fuente de alimentación 24Vcc no incluida

CARRIL ELECTRIFICADO	FMCB-3DC*	24 Vcc	2,3 W	○	0,28	176,75 €
----------------------	-----------	--------	-------	---	------	----------

* Fuente de alimentación 24Vcc no incluida

ADOSADO A TECHO	FMSB-3DC*	24 Vcc	2,3 W	○	0,37	142,25 €
	FMSB-3	230 Vca	2,3 W	○	0,42	201,20 €

* Fuente de alimentación 24Vcc no incluida

+ Añadir referencia CORE N35



CORE N50



FOGO METAL ROD

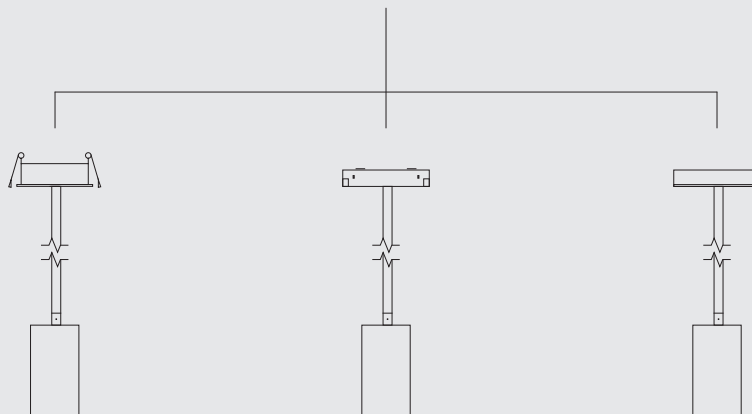

EMPOTRADO A TECHO

CARRIL ELECTRIFICADO
230 Vca

ADOSADO A TECHO

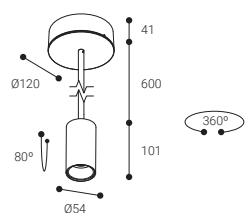
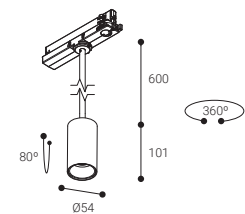
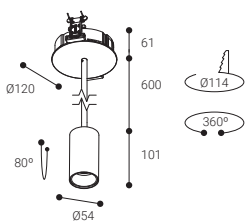

IP 20

	REF.	⚡	W	📐	🏠	PVP (€)
EMPOTRADO A TECHO	FMRB-52	230 Vca	6,9 W	○	0,42	181,35 €
	FMRDB-52	230 Vca	6,9 W	○	0,42	211,35 €

CARRIL ELECTRIFICADO	FMCB-52	230 Vca	6,9 W	○	0,47	130,60 €
	FMADB-52	230 Vca	6,9 W	○	0,47	192,10 €

ADOSADO A TECHO	FMSB-52	230 Vca	6,9 W	○	0,43	181,35 €
	FMSDB-52	230 Vca	6,9 W	○	0,43	211,35 €

+ Añadir referencia CORE N50

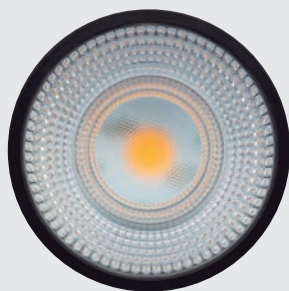



CORE N110



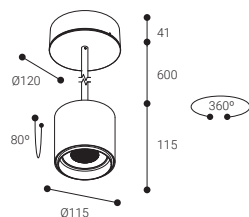
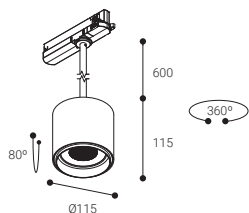
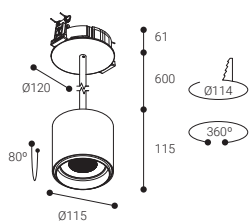
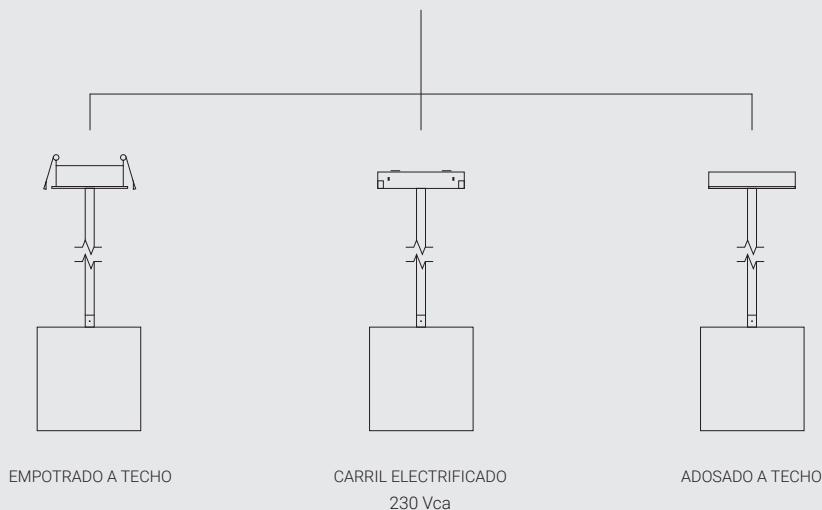



FOGO METAL ROD



IP 20

	REF.	⚡	W	📐	🏠	PVP (€)
EMPOTRADO A TECHO	FMRB-13	230 Vca	11,8 W	○	0,80	172,50 €
	FMRB-16	230 Vca	20,4 W	○	0,80	172,50 €
	 FMRDB-13	230 Vca	11,8 W	○	0,80	202,50 €
	 FMRDB-16	230 Vca	20,4 W	○	0,80	202,50 €

CARRIL ELECTRIFICADO	FMCB-13	230 Vca	11,8 W	○	0,77	137,50 €
	FMCB-16	230 Vca	20,4 W	○	0,77	137,50 €
	 FMCDB-13	230 Vca	11,8 W	○	0,77	199,00 €
	 FMCDB-16	230 Vca	20,4 W	○	0,77	199,00 €

ADOSADO A TECHO	FMSB-13	230 Vca	11,8 W	○	0,80	172,50 €
	FMSB-16	230 Vca	20,4 W	○	0,80	172,50 €
	 FMSDB-13	230 Vca	11,8 W	○	0,80	202,50 €
	 FMSDB-16	230 Vca	20,4 W	○	0,80	202,50 €

+ Añadir referencia CORE N110

ELEMENT

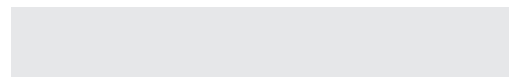



LUFT



FOCX-3

Colores estándar

Gama de colores disponibles



— Código color



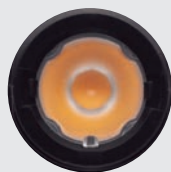

CORE N35



LUFT

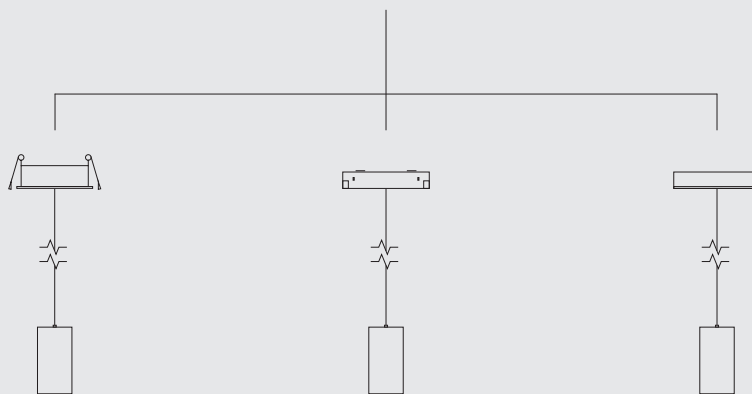

EMPOTRADO A TECHO

CARRIL ELECTRIFICADO
24 Vcc

ADOSADO A TECHO

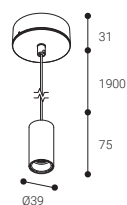
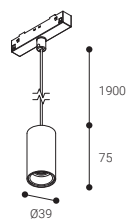
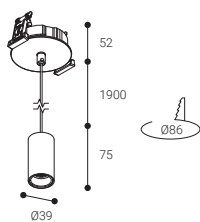

IP 20

	REF.	⚡	W	🌀	🏠	PVP (€)
EMPOTRADO A TECHO	LURB-3DC*	24 Vcc	2,3 W	○	0,23	234,75 €
	LURB-3	230 Vca	2,3 W	○	0,28	259,20 €

* Fuente de alimentación 24Vcc no incluida

CARRIL ELECTRIFICADO	LUCB-3DC*	24 Vcc	2,3 W	○	0,14	200,25 €
----------------------	-----------	--------	-------	---	------	----------

* Fuente de alimentación 24Vcc no incluida

ADOSADO A TECHO	LUSB-3DC*	24 Vcc	2,3 W	○	0,23	234,75 €
	LUSB-3	230 Vca	2,3 W	○	0,28	224,70 €

* Fuente de alimentación 24Vcc no incluida

+ Añadir referencia CORE N35



CORE N50



LUFT

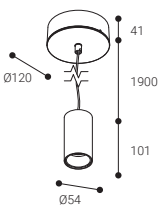
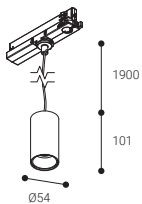
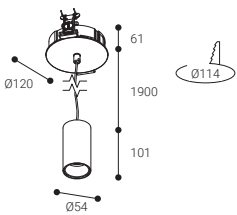
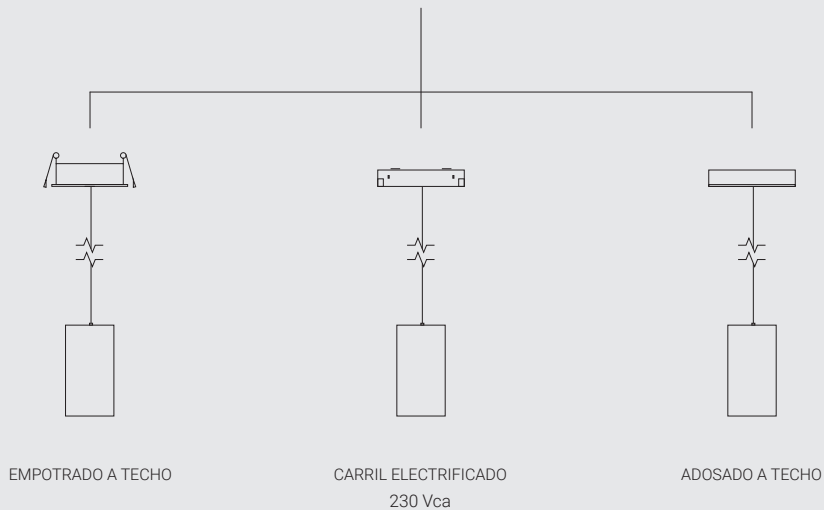

IP 20

	REF.	⚡	W	🌀	🏠	PVP (€)
EMPOTRADO A TECHO	LURB-52	230 Vca	6,9 W	○	0,29	218,50 €
	LURDB-52	230 Vca	6,9 W	○	0,29	248,50 €

CARRIL ELECTRIFICADO	LUCB-52	230 Vca	6,9 W	○	0,36	167,75 €
	LUCDB-52	230 Vca	6,9 W	○	0,36	229,25 €

ADOSADO A TECHO	LUSB-52	230 Vca	6,9 W	○	0,29	218,50 €
	LUSDB-52	230 Vca	6,9 W	○	0,29	248,50 €

+ Añadir referencia CORE N50

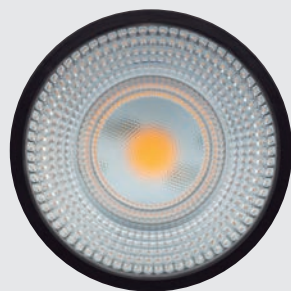

CORE N110



LUFT

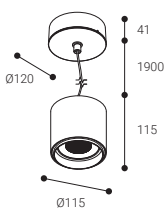
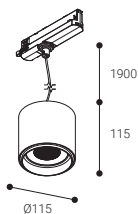
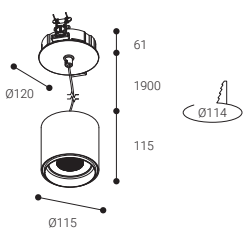
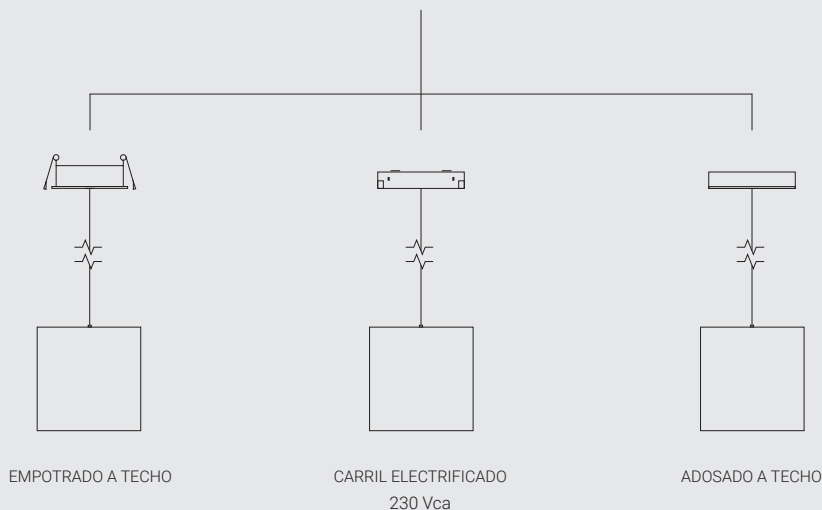

IP 20

	REF.	⚡	W	🌀	🏠	PVP (€)
EMPOTRADO A TECHO	LURB-13	230 Vca	11,8 W	○	0,53	209,75 €
	LURB-16	230 Vca	20,4 W	○	0,53	209,75 €
	LURDB-13	230 Vca	11,8 W	○	0,53	239,75 €
	LURDB-16	230 Vca	20,4 W	○	0,53	239,75 €

CARRIL ELECTRIFICADO	LUCB-13	230 Vca	11,8 W	○	0,58	174,75 €
	LUCB-16	230 Vca	20,4 W	○	0,58	174,75 €
	LUCDB-13	230 Vca	11,8 W	○	0,58	236,25 €
	LUCDB-16	230 Vca	20,4 W	○	0,58	236,25 €

ADOSADO A TECHO	LUSB-13	230 Vca	11,8 W	○	0,50	209,75 €
	LUSB-16	230 Vca	20,4 W	○	0,50	209,75 €
	LUSDB-13	230 Vca	11,8 W	○	0,50	239,75 €
	LUSDB-16	230 Vca	20,4 W	○	0,50	239,75 €

+ Añadir referencia CORE N110



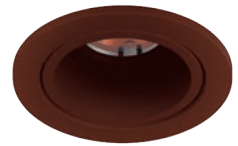
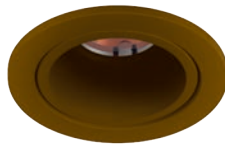
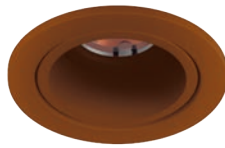

ZEME

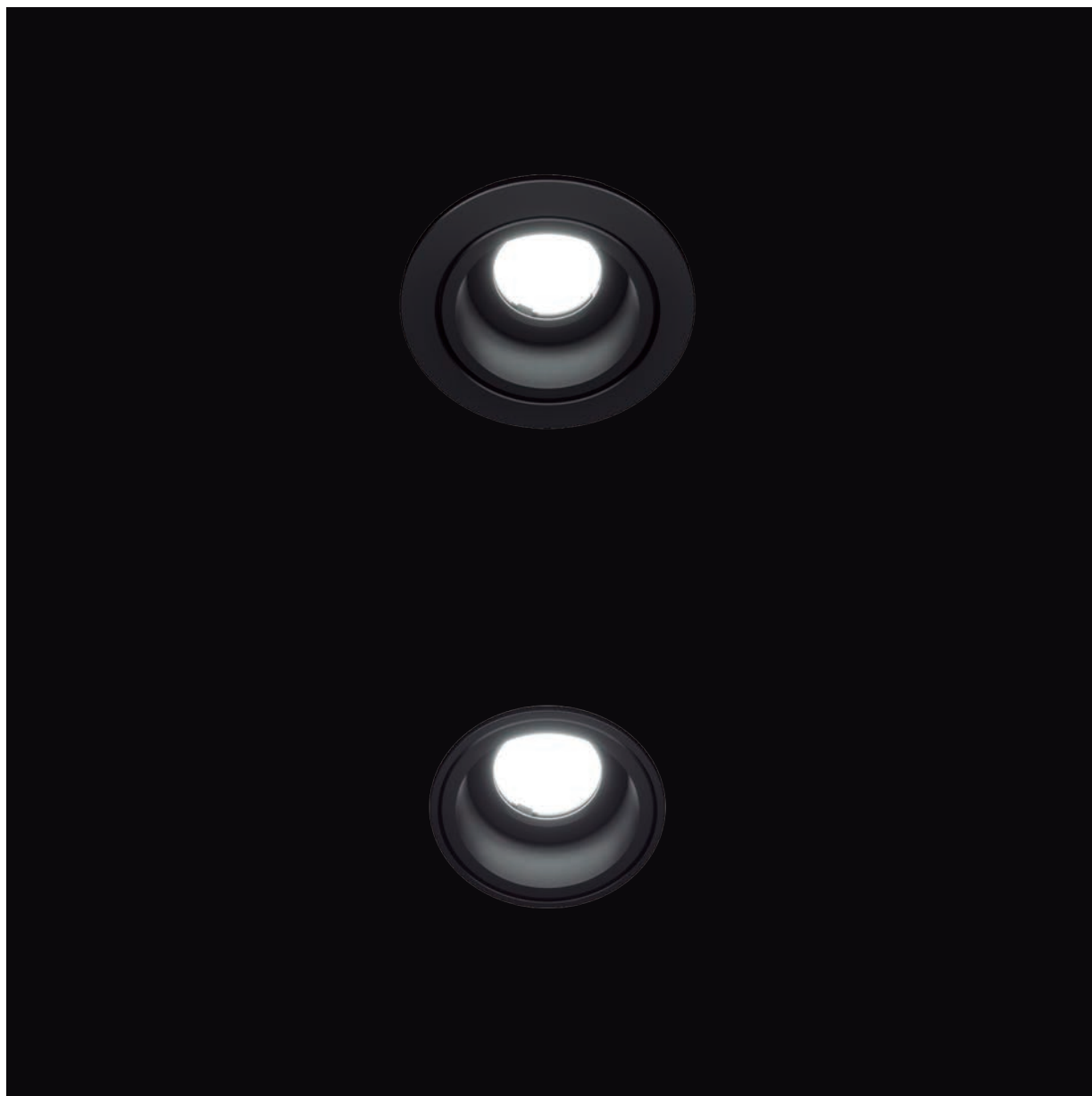

FOCX-3

Colores estándar

Gama de colores disponibles



— Código color



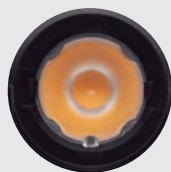

CORE N35



ZEME



EMPOTRADO A TECHO



TRIMLESS

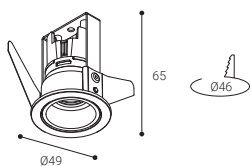

IP 20

	REF.	⚡	W	📐	🏠	PVP (€)
EMPOTRADO A TECHO	ZEB-3DC*	24 Vcc	2,3 W	○	0,05	27,25 €

* Fuente de alimentación 24Vcc no incluida

Colores | Estándar ○ ● | Gama de colores disponibles ● ● ● ● Añadir 5,00 € al PVP indicado

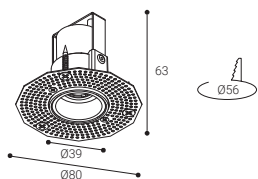

TRIMLESS	ZT-3DC*	24 Vcc	2,3 W	○	0,14	31,25 €
-----------------	----------------	--------	-------	---	------	----------------

* Fuente de alimentación 24Vcc no incluida



Añadir referencia CORE N35

ZEM

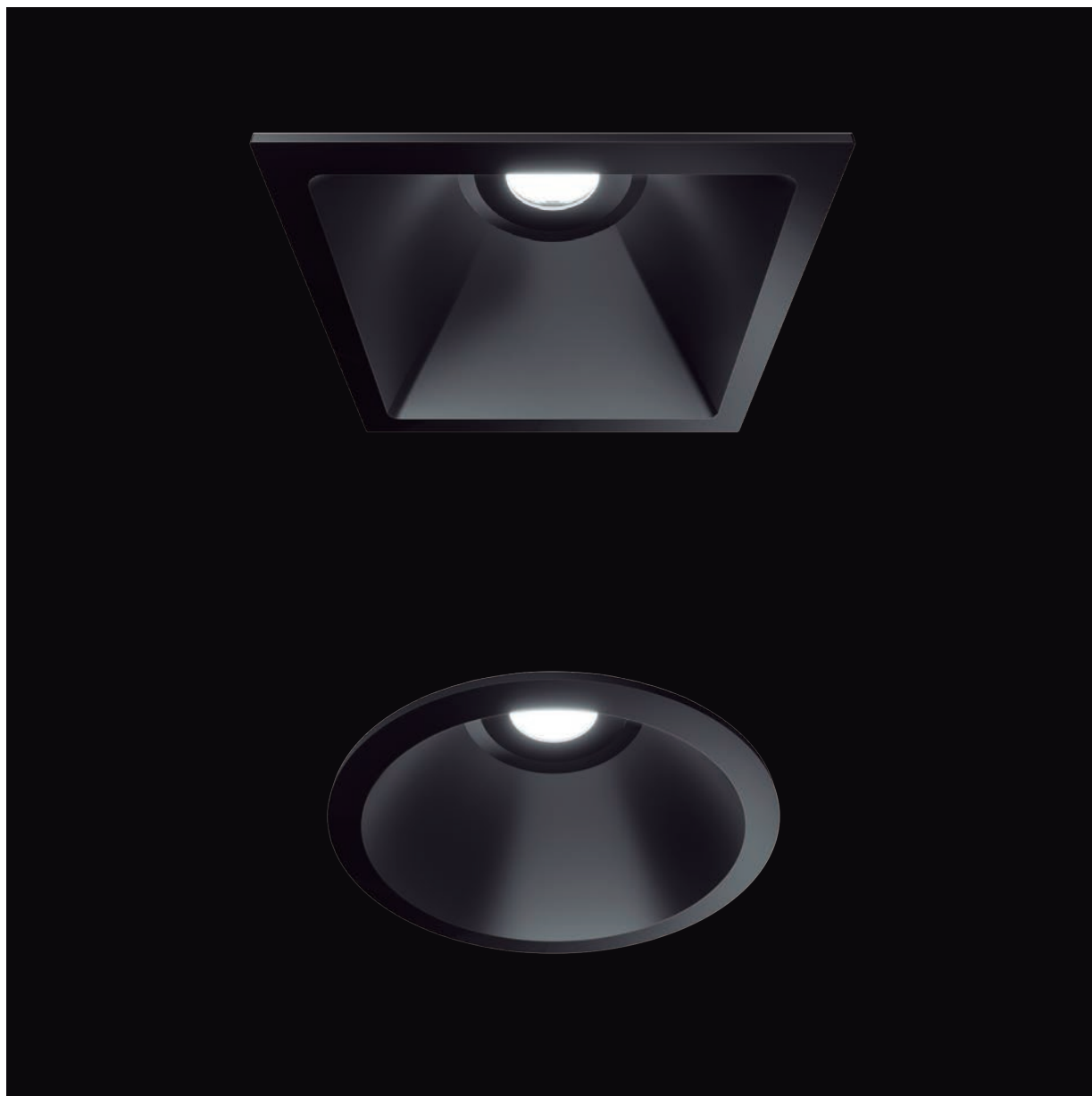

FOCX-3

Colores estándar

Gama de colores disponibles



— Código color



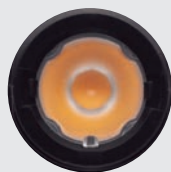





CORE N35

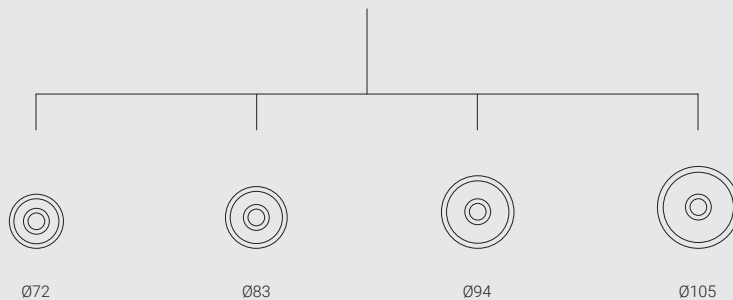

ZEM



IP 20

	REF.		W			PVP (€)
EMPOTRADO A TECHO	ZR72B-3DC*	24 Vcc	2,3 W	○	0,05	18,25 €
	ZR83B-3DC*	24 Vcc	2,3 W	○	0,06	19,25 €
	ZR94B-3DC*	24 Vcc	2,3 W	○	0,07	20,25 €
	ZR105B-3DC*	24 Vcc	2,3 W	○	0,08	21,25 €

+ Añadir referencia CORE N35

* Fuente de alimentación 24Vcc no incluida

ZR72

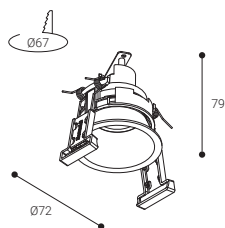

ZR83

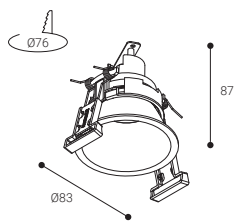

ZR94

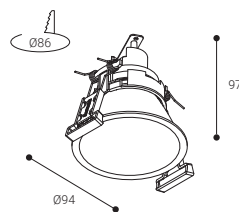

ZR105

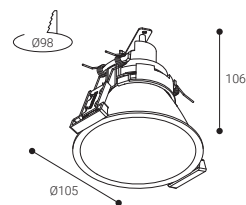

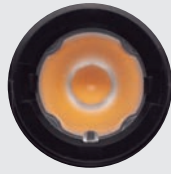

CORE N35



ZEM

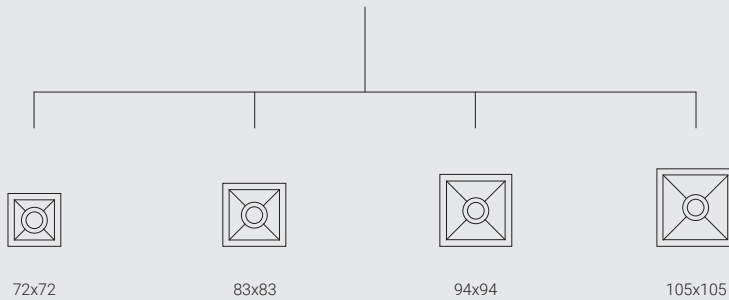

IP 20

	REF.	⚡	W	📐	🏠	PVP (€)
EMPOTRADO A TECHO	ZQ72B-3DC*	24 Vcc	2,3 W	○	0,05	18,25 €
	ZQ83B-3DC*	24 Vcc	2,3 W	○	0,06	19,25 €
	ZQ94B-3DC*	24 Vcc	2,3 W	○	0,07	20,25 €
	ZQ105B-3DC*	24 Vcc	2,3 W	○	0,08	21,25 €

+ Añadir referencia CORE N35

* Fuente de alimentación 24Vcc no incluida

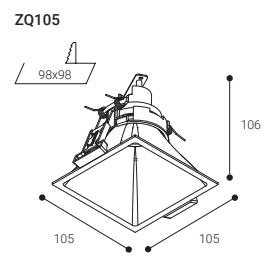
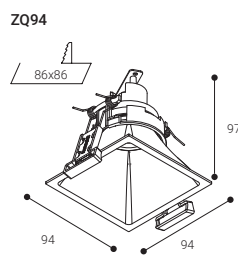
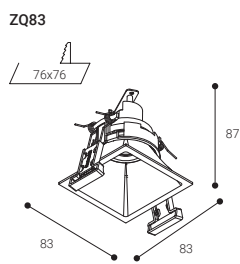
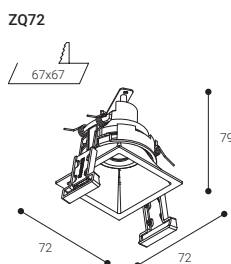





CORE N50

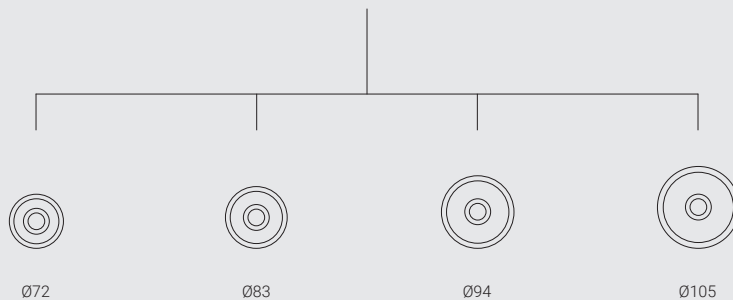

ZEM



IP 20

	REF.	⚡	W	🌀	🏠	PVP (€)
EMPOTRADO A TECHO	ZR72B-52	230 Vca	6,9 W	○	0,09	32,25 €
	ZR83B-52	230 Vca	6,9 W	○	0,10	33,25 €
	ZR94B-52	230 Vca	6,9 W	○	0,12	34,25 €
	ZR105B-52	230 Vca	6,9 W	○	0,12	35,25 €
	ZR72DB-52	230 Vca	6,9 W	○	0,14	82,25 €
	 ZR83DB-52	230 Vca	6,9 W	○	0,15	83,25 €
	ZR94DB-52	230 Vca	6,9 W	○	0,17	84,25 €
	ZR105DB-52	230 Vca	6,9 W	○	0,17	85,25 €

+
Añadir referencia CORE N50

ZR72

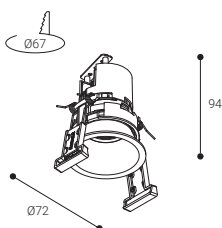

ZR83

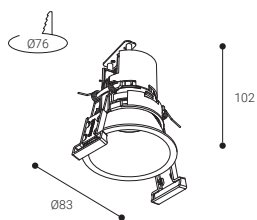

ZR94

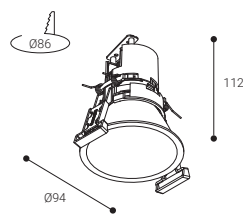

ZR105

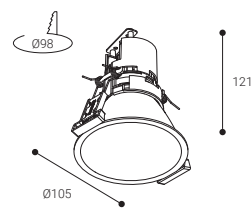



CORE N50



ZEM

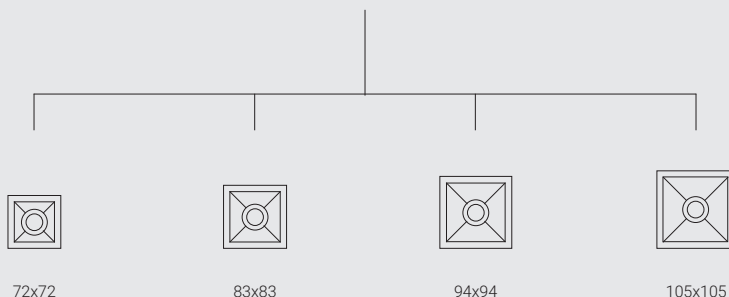

72x72

83x83

94x94

105x105

IP 20

	REF.	⚡	W	📐	🏠	PVP (€)
EMPOTRADO A TECHO	ZQ72B-52	230 Vca	6,9 W	○	0,12	32,25 €
	ZQ83B-52	230 Vca	6,9 W	○	0,14	33,25 €
	ZQ94B-52	230 Vca	6,9 W	○	0,15	34,25 €
	ZQ105B-52	230 Vca	6,9 W	○	0,15	35,25 €
	ZQ72DB-52	230 Vca	6,9 W	○	0,17	82,25 €
	ZQ83DB-52	230 Vca	6,9 W	○	0,17	83,25 €
	 ZQ94DB-52	230 Vca	6,9 W	○	0,19	84,25 €
	ZQ105DB-52	230 Vca	6,9 W	○	0,20	85,25 €

+
Añadir referencia
CORE N50

ZQ72

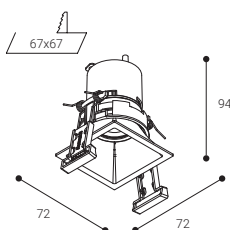

ZQ83

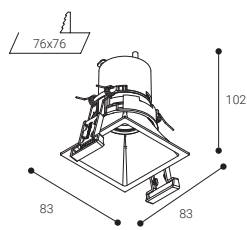

ZQ94

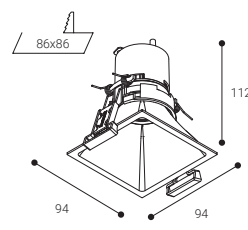

ZQ105

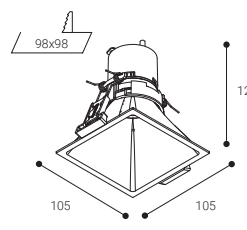



ACCESORIOS





RAIL

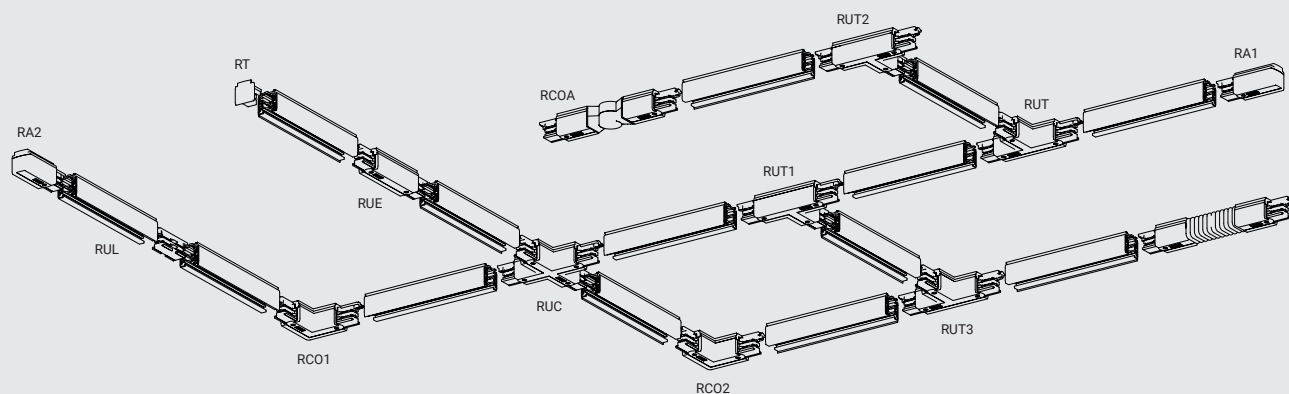

Las familias RAIL y RAIL MICRO de Normalit son un completo sistema de rail electrificado rápido y fácil de instalar. Además de los carriles, el sistema se completa con otros accesorios de conexión y suspensión. Su gran versatilidad lo hacen el sistema ideal para instalarse en museos, oficinas, comercios, escaparates, etc.

Permiten mucha flexibilidad en los proyectos de iluminación. Cualquier cambio de las luminarias en función de nuevos requerimientos lumínicos se puede realizar muy fácilmente.



RAILES

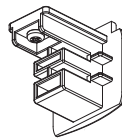
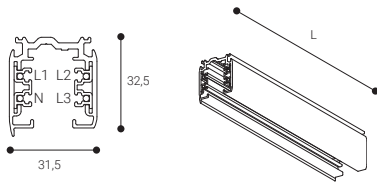

REF.	L (mm)		PVP (€)	REF.	L (mm)		PVP (€)
R2-3							
R2B	2000	○	77,50 €	R2DB	2000	○	178,73 €
R2N	2000	●	77,50 €	R2DN	2000	●	178,73 €
R3B	3000	○	107,78 €	R3DB	3000	○	265,62 €
R3N	3000	●	107,78 €	R3DN	3000	●	265,62 €

REF.		PVP (€)
RT. Tapa final		
RTB	○	2,47 €
RTN	●	2,47 €

ALIMENTADORES

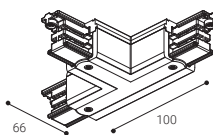
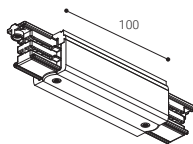

POLARIDAD

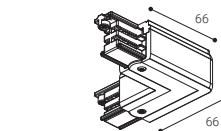
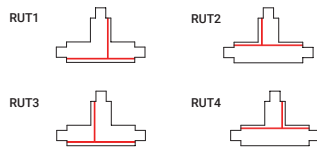

POLARIDAD

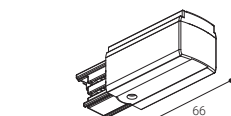

POLARIDAD



REF.		PVP (€)	REF.		PVP (€)
RUE. Alimentador Central					
RUEB	○	45,48 €	RUEDB	○	88,74 €
RUEN	●	45,48 €	RUEDN	●	88,74 €

REF.		PVP (€)	REF.		PVP (€)
RUT. Alimentador T					
RUT1B	○	62,79 €	RUT1DB	○	129,16 €
RUT1N	●	62,79 €	RUT1DN	●	129,16 €
RUT2B	○	62,79 €	RUT2DB	○	129,16 €
RUT2N	●	62,79 €	RUT2DN	●	129,16 €
RUT3B	○	62,79 €	RUT3DB	○	129,16 €
RUT3N	●	62,79 €	RUT3DN	●	129,16 €
RUT4B	○	62,79 €	RUT4DB	○	129,16 €
RUT4N	●	62,79 €	RUT4DN	●	129,16 €

REF.		PVP (€)	REF.		PVP (€)
RCO. Alimentador L					
RCO1B	○	51,79 €	RCO1DB	○	88,74 €
RCO1N	●	51,79 €	RCO1DN	●	88,74 €
RCO2B	○	51,79 €	RCO2DB	○	88,74 €
RCO2N	●	51,79 €	RCO2DN	●	88,74 €

REF.		PVP (€)	REF.		PVP (€)
RA. Alimentador inicial					
RA1B	○	15,20 €	RA1DB	○	43,51 €
RA1N	●	15,20 €	RA1DN	●	43,51 €
RA2B	○	15,20 €	RA2DB	○	43,51 €
RA2N	●	15,20 €	RA2DN	●	43,51 €

CONECTORES

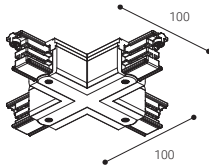
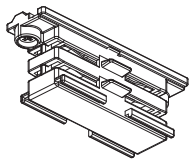

POLARIDAD

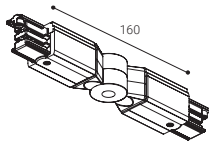
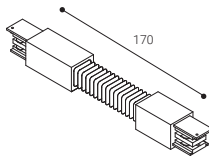
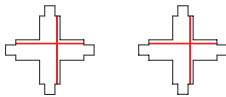

REF.		PVP (€)	REF.		PVP (€)
RUL. Conector lineal					
RULB	○	10,26 €	RULDB	○	33,74 €
RULN	●	10,26 €	RULDN	●	33,74 €

RUC. Conector X					
RUCB	○	79,10 €	RUCDB	○	158,08 €
RUCN	●	79,10 €	RUCDN	●	158,08 €

RUF. Conector flexible					
RUFB	○	95,30 €	RUFDB	○	184,04 €
RUFN	●	95,30 €	RUFDN	●	184,04 €

RCOA. Conector articulado					
RCOAB	○	50,55 €			
RCOAN	●	50,55 €			



HERRAMIENTAS

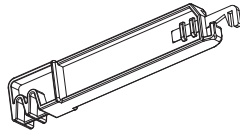

RH. Herramienta de doblado

La herramienta de doblado es necesaria para el correcto conexionado de los alimentadores y conectores.

REF.  PVP (€)

RH **26,70 €**



RE. Toma de corriente

- 16 A, 250 V/400 V, Seguridad, Clase 1
- Máxima Tensión 100N
- Máxima torsión 2.5 Nm
- Distancia máxima de conexión entre conductores 5 x 2,5 mm²

REB ○ **56,86 €**

REN ● **56,86 €**

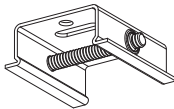

RSB. Soporte fijación a techo

RSBB ○ **2,84 €**

RSBN ● **2,84 €**

RAIL MICRO



RAILES

REF.	L (mm)		PVP (€)
RP. Rail micro			
RP1B	1000	○	95,45 €
RP1N	1000	●	95,45 €
RP2B	2000	○	181,58 €
RP2N	2000	●	181,58 €
RP3B	3000	○	267,44 €
RP3N	3000	●	267,44 €

REF.	L (mm)		PVP (€)
RPE. Rail micro empotrable			
RPE1B	1000	○	110,07 €
RPE1N	1000	●	120,06 €
RPE2B	2000	○	210,60 €
RPE2N	2000	●	230,40 €
RPE3B	3000	○	310,55 €
RPE3N	3000	●	340,34 €

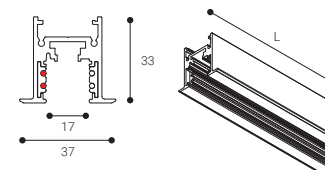
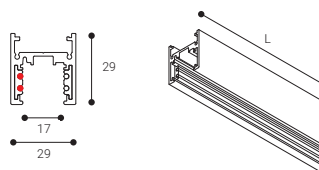

RPT. Tapa final ciega

RPTB	○	16,16 €
RPTN	●	16,16 €

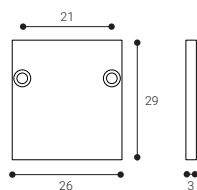

RPTA. Tapa final con orificio

RPTAB	○	18,81 €
RPTAN	●	18,81 €

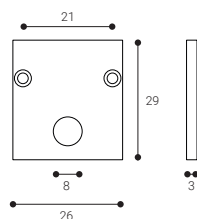

RPETC. Tapa final RPE

RPETCB	○	26,33 €
RPETCN	●	26,33 €

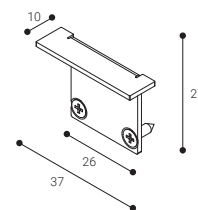

ALIMENTADORES

RPA1. Alimentador derecha

RPA1B	○	39,83 €
RPA1N	●	39,83 €

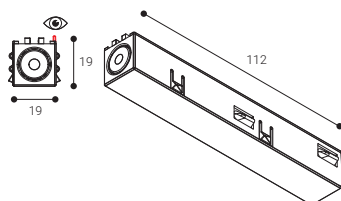

RPA2. Alimentador izquierda

RPA2B	○	39,83 €
RPA2N	●	39,83 €

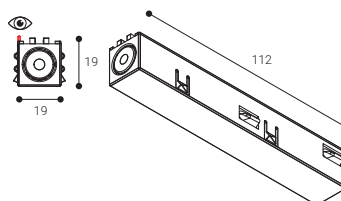



RPUL. Unión mecánica lineal

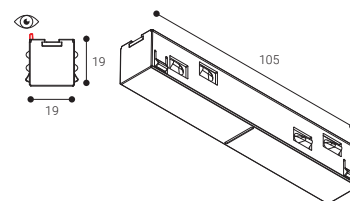

RPULB	○	31,50 €
RPULN	●	31,50 €



CONECTORES

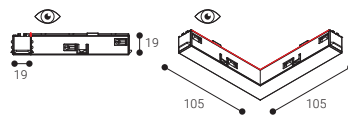

REF.		PVP (€)
RPUC1. Conector codo interno		
RPUC1B		99,50 €
RPUC1N		99,50 €



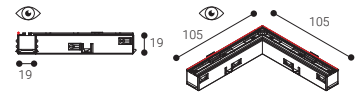



REF.		PVP (€)
RPUC2. Conector codo externo		
RPUC2B		99,50 €
RPUC2N		99,50 €



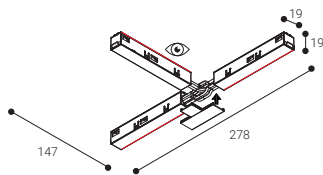



UNIÓN ELÉCTRICA

REF.		PVP (€)
RPUT1. Unión en T externa derecha		
RPUT1B		146,88 €
RPUT1N		146,88 €

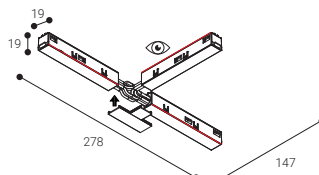



REF.		PVP (€)
RPUT2. Unión en T interna izquierda		
RPUT2B		146,88 €
RPUT2N		146,88 €



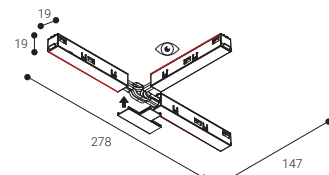

REF.		PVP (€)
RPUT3. Unión en T externa izquierda		
RPUT3B		146,88 €
RPUT3N		146,88 €

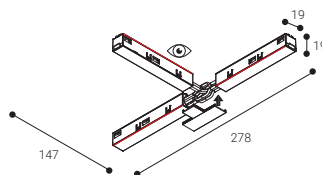

RPUT4. Unión en T interna derecha		
RPUT4B		146,88 €
RPUT4N		146,88 €



RPUX. Unión en cruz		
RPUXB		178,43 €
RPUXN		178,43 €

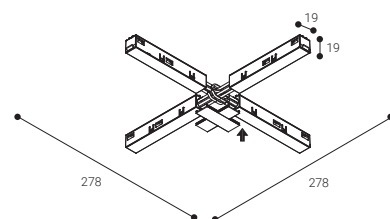



UNIÓN MECÁNICA

REF.		PVP (€)
RPEUL. Unión mecánica lineal		
RPEULB	○	15,21 €
RPEULN	●	15,21 €

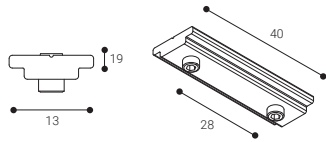

REF.		PVP (€)
RPUTM. Unión mecánica en T		
RPUTMB	○	117,14 €
RPUTMN	●	117,14 €

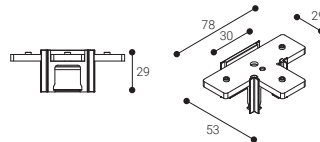

REF.		PVP (€)
RPUXM. Unión mecánica en cruz		
RPUXMB	○	117,14 €
RPUXMN	●	117,14 €

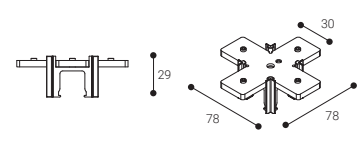

REF.		PVP (€)
RPUCM. Unión mecánica codo RP		
RPUCMB	○	127,22 €
RPUCMN	●	127,22 €

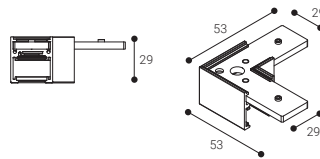

REF.		PVP (€)
RPEUCM. Unión mecánica codo RPE		
RPEUCMB	○	130,73 €
RPEUCMN	●	130,73 €

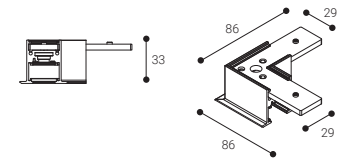

HERRAMIENTAS

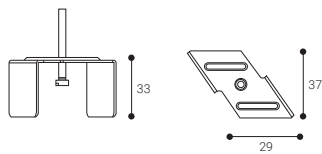

REF.	PVP (€)
RPEFT. Fijación techo RPE	
RPEFT	26,96 €

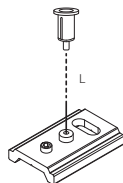

RPKSUS. Kit de suspensión de carril	
RPKSUS	13,73 €

FUENTES DE ALIMENTACIÓN 24 Vcc

IP 20

DIMENSIONES

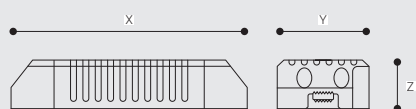

REF.	X	Y	Z
BE03024	153	41,4	32
BE06024	180	52	30
BE07524	180	52	30
BE12024	300	40	30
BE18024	345	50	35
BEU35024	220	62	31

BE03524D	195	43	30,2
BE06024D	225	43	30,2
BE10024D	295	43	29,8
BE15024D	325	43	30,2

REF. W PVP (€)

ESTÁNDAR

BE03024	30	28,66 €
BE06024	60	36,55 €
BE07524	75	41,75 €
BE12024	120	47,05 €
BE18024	180	99,07 €
BEU35024	350	184,07 €

REF.  PVP (€)



BE03524D	35	77,44 €
BE06024D	60	94,09 €
BE10024D	100	112,69 €
BE15024D	150	146,22 €

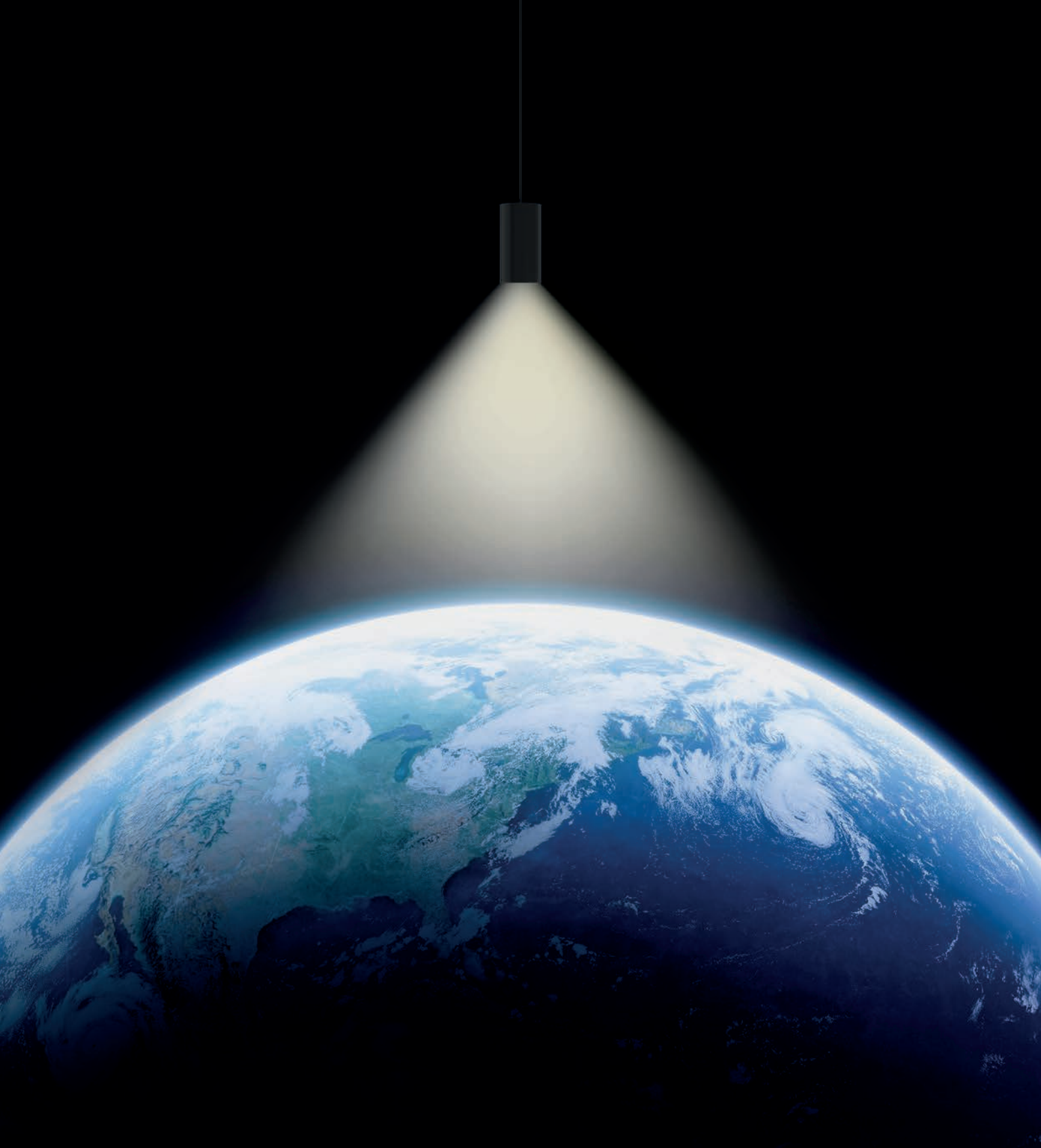

ELEMENT

OTRA FORMA DE ILUMINAR
EL PLANETA



Normagrup



Normagrup Technology
 Sede central / Headquarters
 Parque Tecnológico de Asturias. C/Ablanal, 1
 33428 Llanera (Asturias). España / Spain

Normagrup UK
 Normagrup Netherlands
 Normagrup France

normagrup.com



Normagrup